

Model 1923 Series For Pump-Off Control of Oil Wells

Why the Interface LoadTrol Load Cells are the best in class:

- Capacities – 30K, 40K, 50K
- Developed, field tested, accepted for oil field use
- Transient voltage protection from lightning and or power line disturbances
- Rugged – life exceeds 50,000,000 cycles
- All-weather, waterproof, corrosion resistant
- Performance insensitive to temperature changes
- No welding or special brackets required
- Installs on polished rod



ACCESSORIES

SA-100 installation kit (bearing plate and spherical washer)
CC-113-XX interconnect cable (XX designates no. of ft.)

SPECIFICATIONS

ACCURACY – MAX	
Static Error Band-% RO	±0.5
TEMPERATURE	
Compensated Range-°F	0 to 150
Compensated Range-°C	-18 to 65
Operating Range-°F	-40 to 175
Operating Range-°C	-40 to 80
Effect on Output-%/°F – MAX	±0.2
Effect on Zero- % RO/°F – MAX	±0.5
ELECTRICAL	
Rated Output-mV/V (nominal)	±2
Zero Balance-%RO	±1
Bridge Resistance-Ohm (nominal)	700
Excitation Voltage-VDC	5-15
Insulation Resistance-Megohm	10
MECHANICAL	
Calibration	Comp
Safe Overload-% CAP	200
Fatigue life-no. of cycles	50,000,000

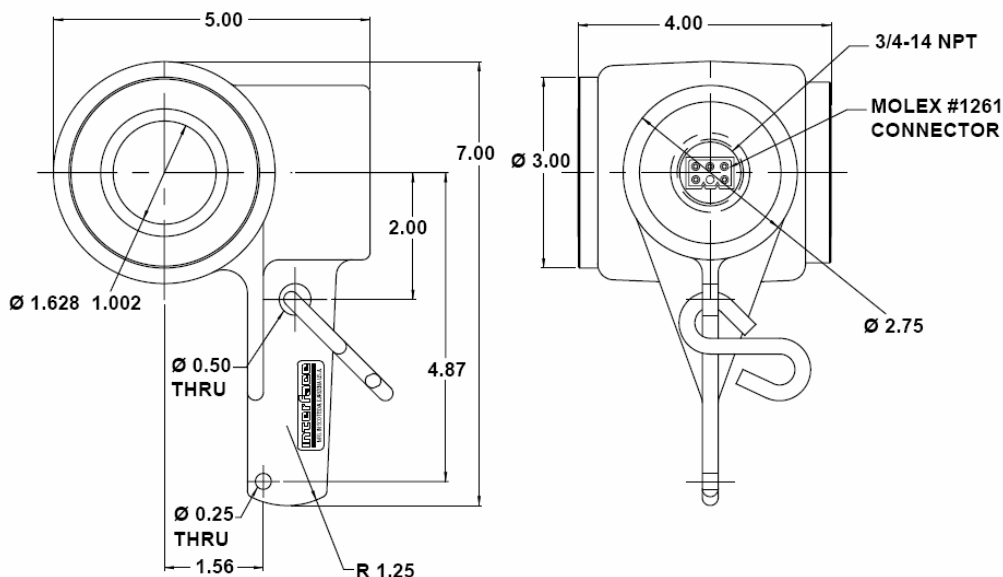

1923
12/22/09